



# Blockchain

---



Sharbel Goriya

Juridisch Medewerker at JPR Advocaten





- Basisprincipes blockchain
- Blockchain 2.0
- Use cases
- Smart contracts
- Complicaties blockchain



**BLOCKCHAIN**



# (in)formele instituties

---

- Overheden
- Banken
- Bedrijven
- Wetgeving
  
- Onzekerheid
- Internationale transacties
  
- Dus: instituties dienen als middel om onzekerheden tussen partijen te verminderen t.b.v. de efficiënte overdracht van waarde.



# Blockchain

---

- Nieuwe institutie
  - Minder onzekerheid tussen partijen
  - Enkel gebaseerd op technologie
- 
- Hoe?

# Blockchain

- Een gedistribueerde database
- Waarin activa en transacties worden geregistreerd
- Alle data wordt beveiligd d.m.v. cryptografie

Dus: Een grootboek waarin staat wie eigenaar is van welke activa, en wie welke transacties heeft verricht.

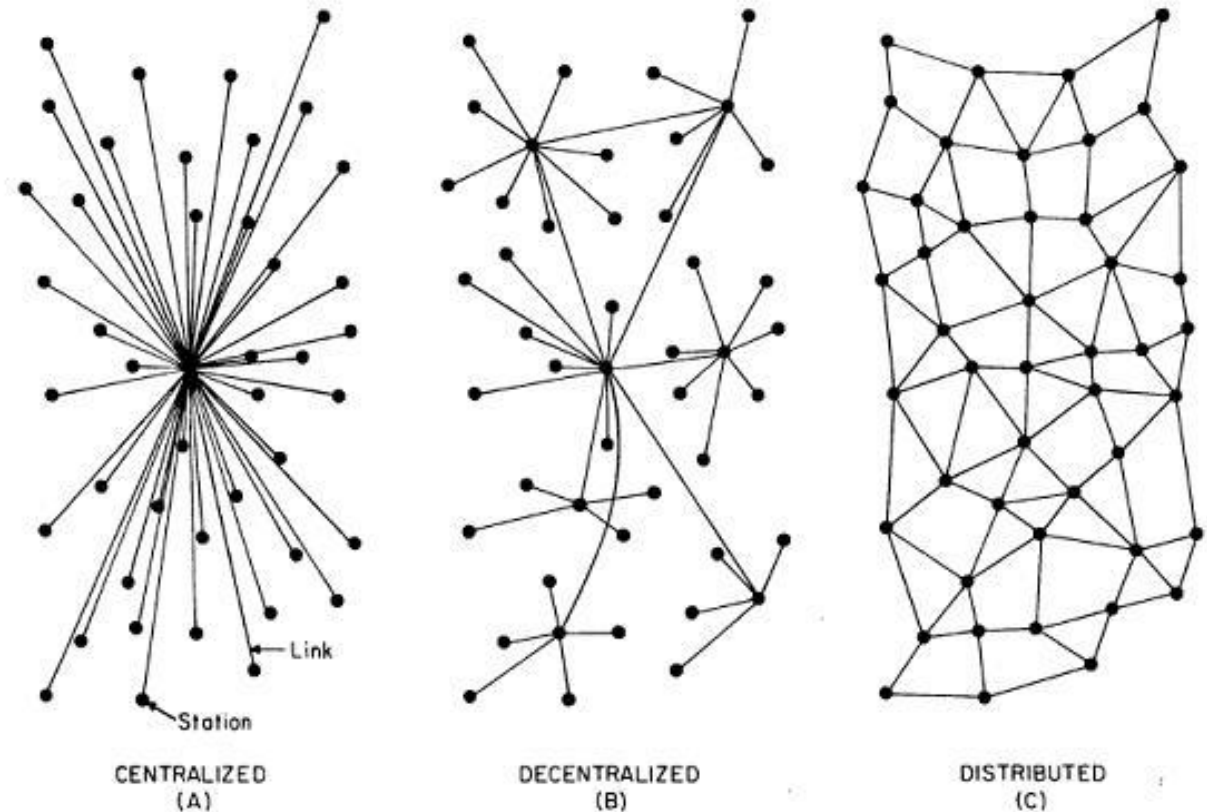



# Blockchain

- Transactiehistorie
- Blokken data
- Cryptografie
- Beveiligde tijdlijn
- Onveranderlijk en fraudebestendig
- Gekopieerd naar alle gebruikers
- Dus: Bij iedere transactie kijkt de Blockchain terug naar de geschiedenis.

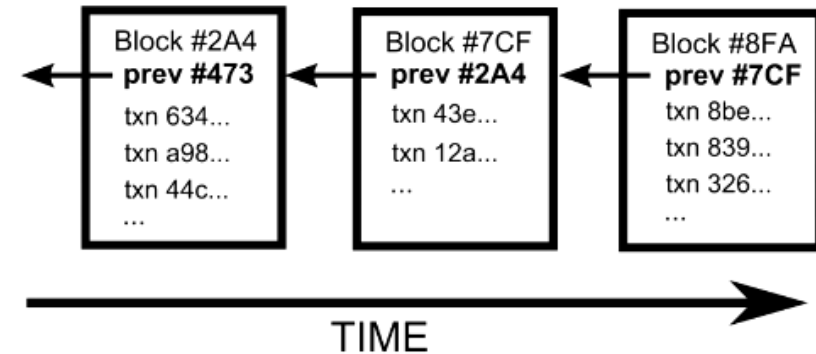



Blockchain 2.0  
(smart contracts)





# Populaire technologie





ADVOCATEN

## Global Charts

### Total Market Capitalization

Zoom 1d 7d 1m 3m 1y YTD ALL

From Dec 29, 2016 To Jan 18, 2018





# Blockchain use cases

---

# Supply chain

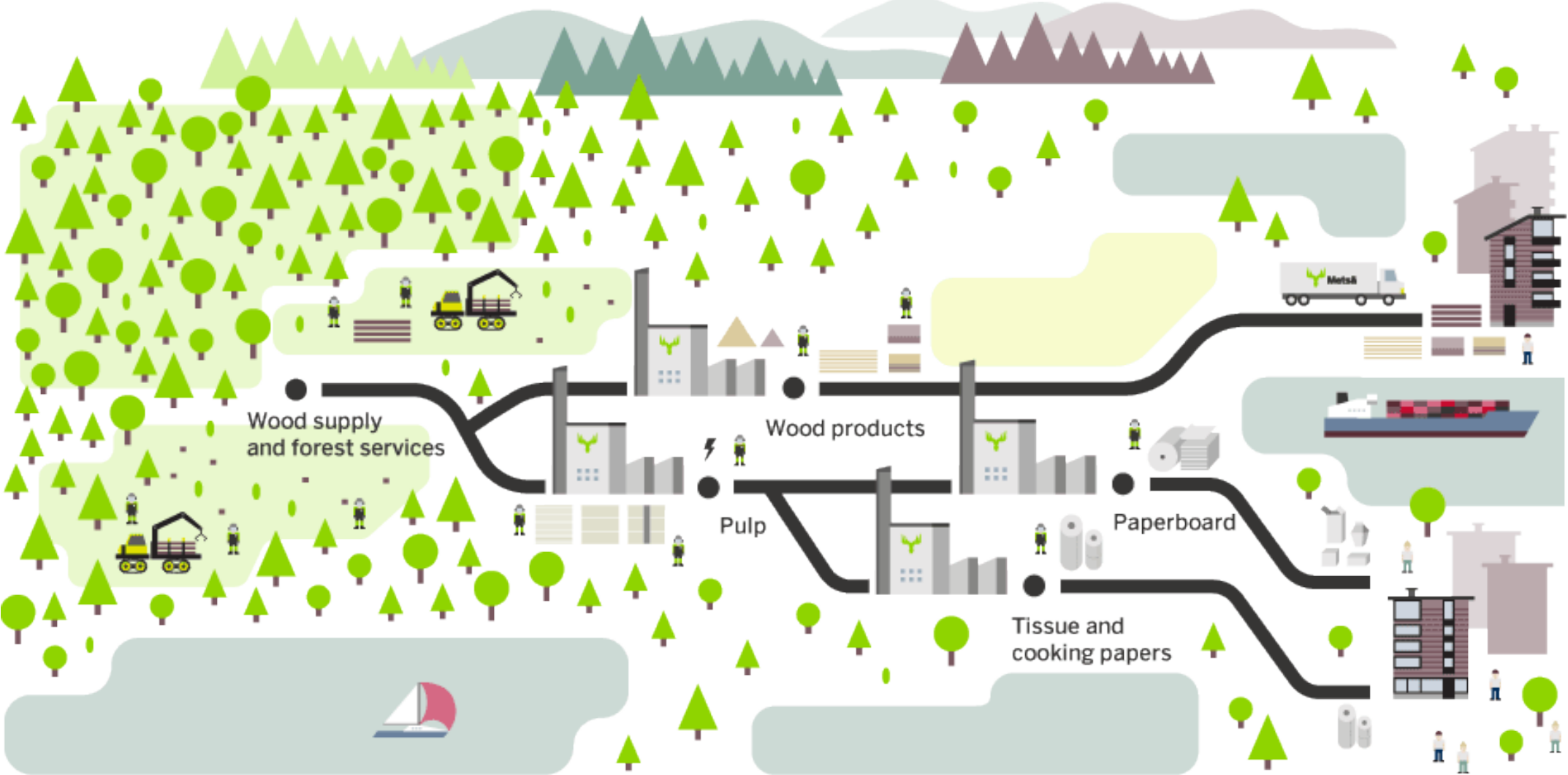



# Blockchain

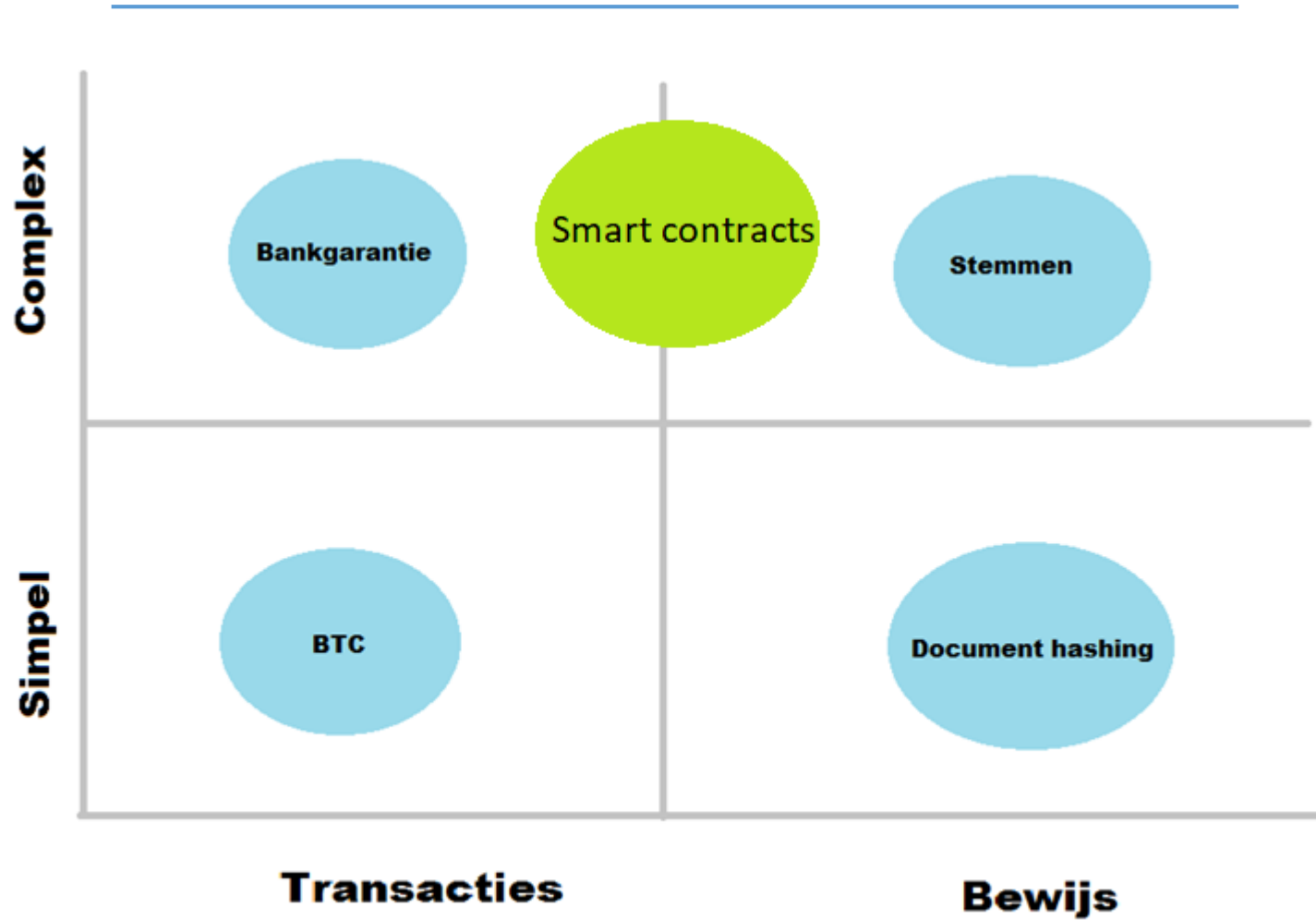



# Smart contract

---

“A [smart contract](#) is a form of contract of self executing code that uses technology to store transactions: (i) in a single, verifiable chain; (ii) that are automatically triggered by messages send to the contract; and (iii) with consensus mechanisms ensuring integrity of the blockchain.”



In Ethereum a “smart contract” is a contract account, can hold balance, but also has associated code, code execution is triggered by transactions (from an EOA) or messages (calls) received from other contracts.

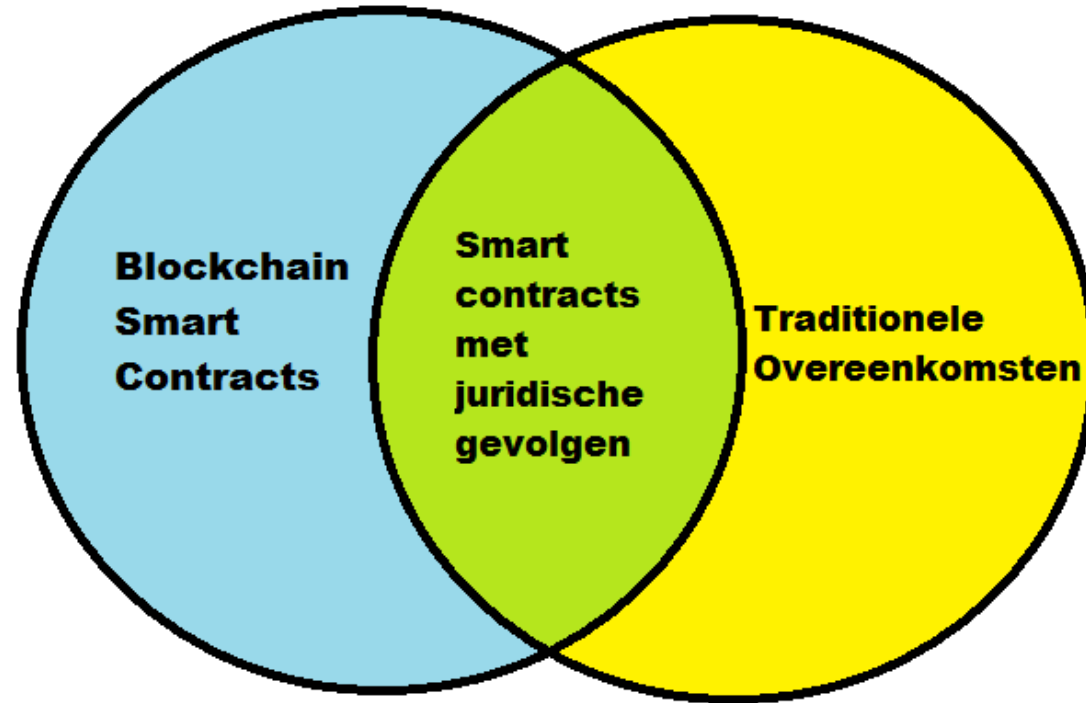

*Smart contracts is een misleidende term*



# Complicaties blockchain





# Garbage In Garbage Out (GIGO)





# De blockchain is onveranderlijk

Smart contract wijzigen?



# Energieverbruik

- Verbruik Zwitserland:  
+/- 60 Terawatt p/j
- Verbruik BTC:  
+/- 60 Terawatt p/j

## Bitcoin Energy Consumption Index

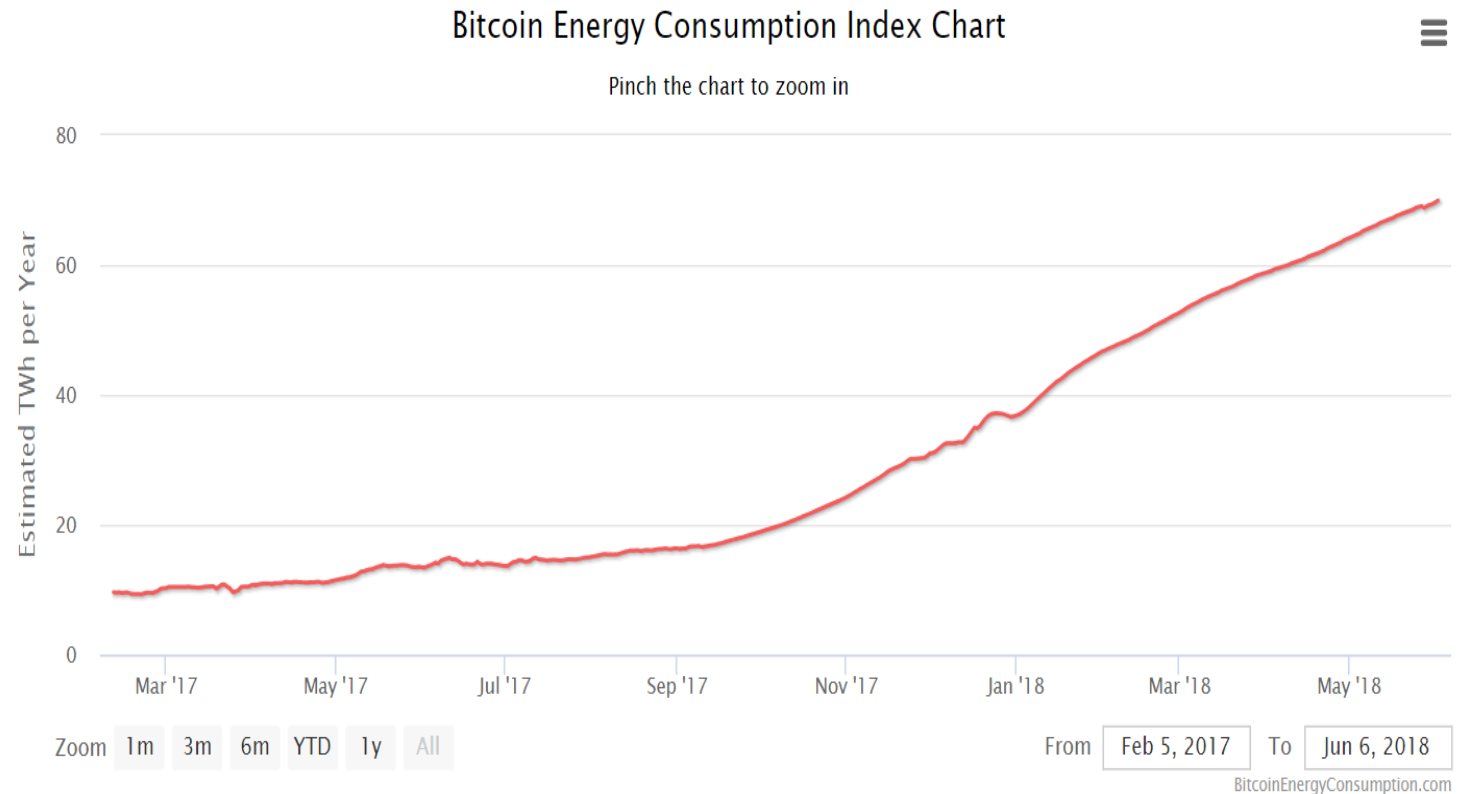



# Kwalificaties op grond van het privacyrecht

ADVOCATEN

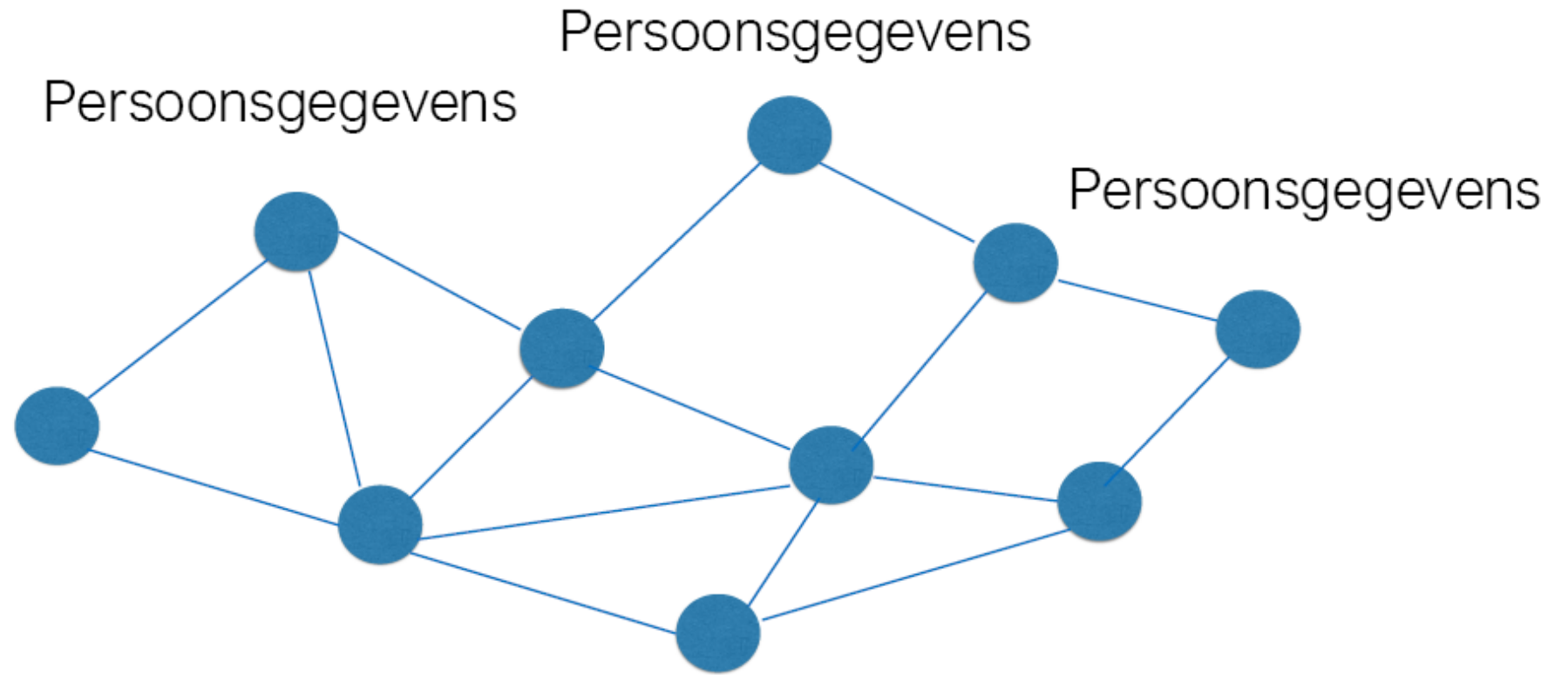



# Recht op verwijdering/vergetelheid

- Gegevens versleutelen
- Wijze van versleutelen verwijderen/vernietigen
  
- Conform AVG?

# Traditionele Database?

## CENTRALIZED DATABASES VS. BLOCKCHAIN

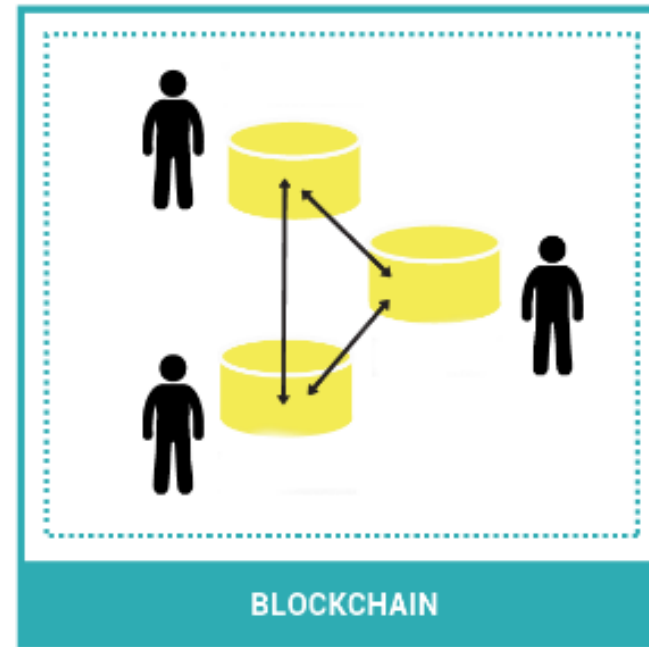
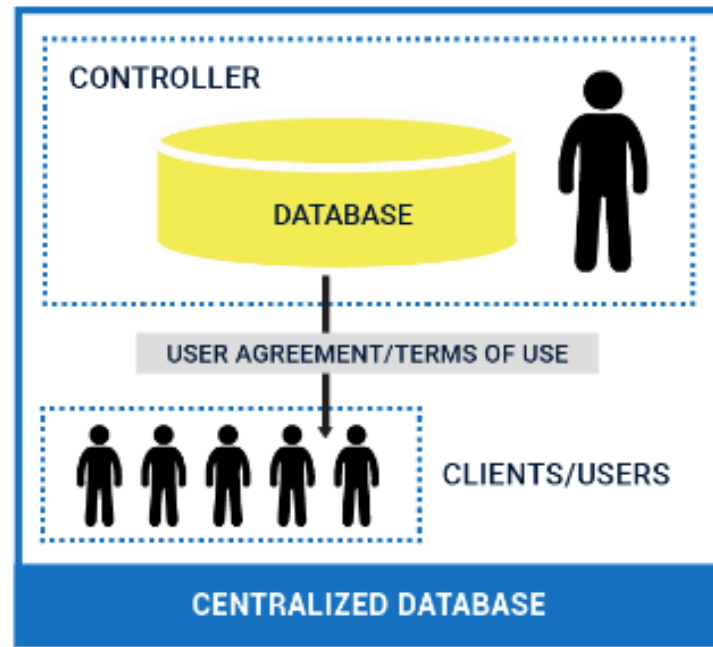



Dank voor uw aandacht!



Sharbel Goriya

Juridisch Medewerker at JPR Advocaten

